

Welcome

to Aachen

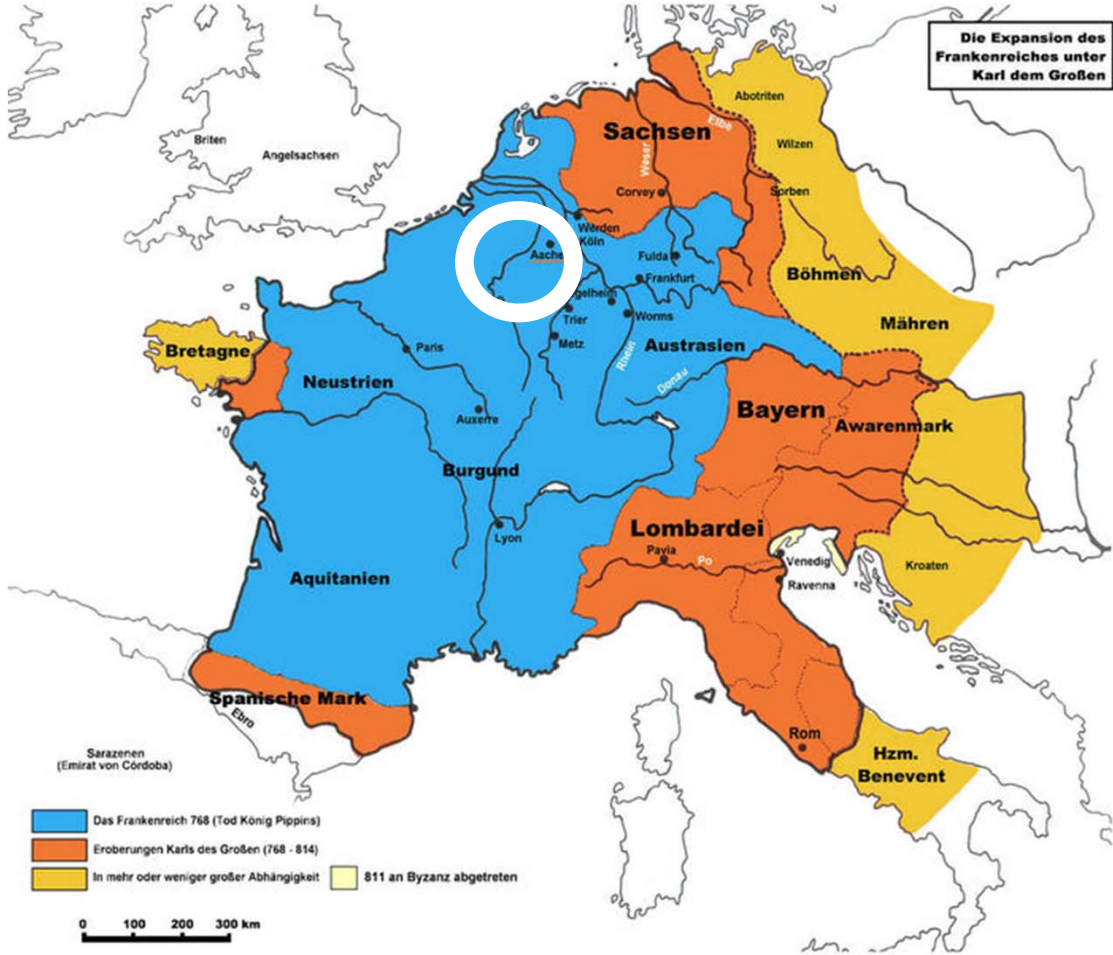

How it all started ...





33,000 Students

RWTH Aachen University
Expenditures incl. UKA

Total: 885 M €

...of which:

417 M € State Funding

226 M € External Funding

242 M € UKA



2,400 Non-academic
Staff & Apprentices



> 5,000 International
Students



3.86 M €
Fundraising



454 Chairs



4,000 Academic
Staff

History of RWTH Aachen University

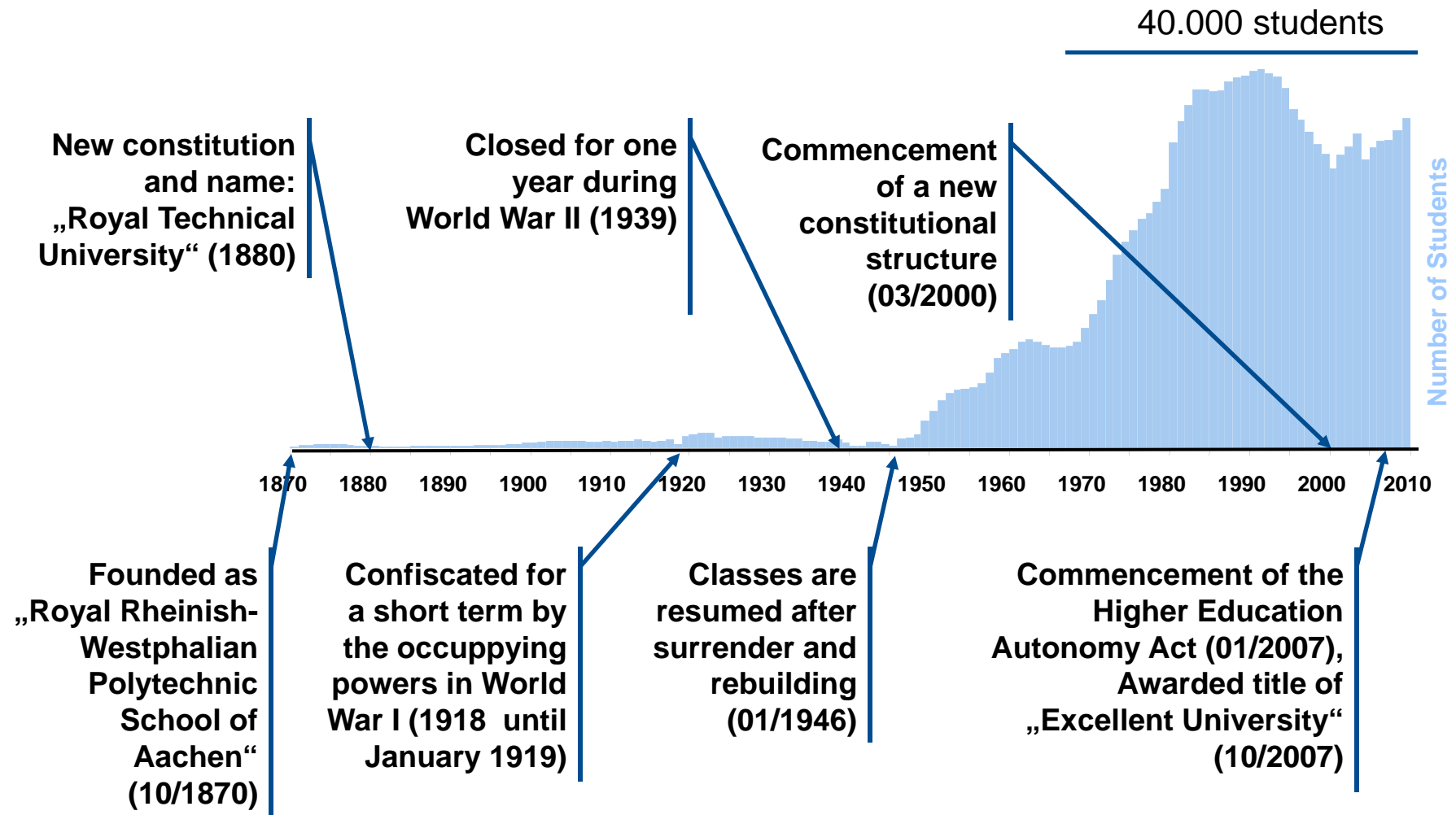

Faculties and Departments

Faculty 1: Mathematics, Computer Sciences & Natural Sciences

Dept. Mathematics, Dept. Comp. Science, Dept. Physics, Dept. Chemistry, Dept. Biology

Faculty 2: Architecture

Faculty 3: Civil Engineering

Faculty 4: Mechanical Engineering

Faculty 5: Georesources & Materials Engineering

Dept. Mining and Waste Management

Dept. Metallurgy

Dept. Geosciences

Faculty 6: Electrical Engineering & Information Technology

Engineering

Faculty 7: Arts & Humanities

Faculty 8: Business & Economics

Faculty 10: Medicine

Students per Discipline – Winter 2010/11

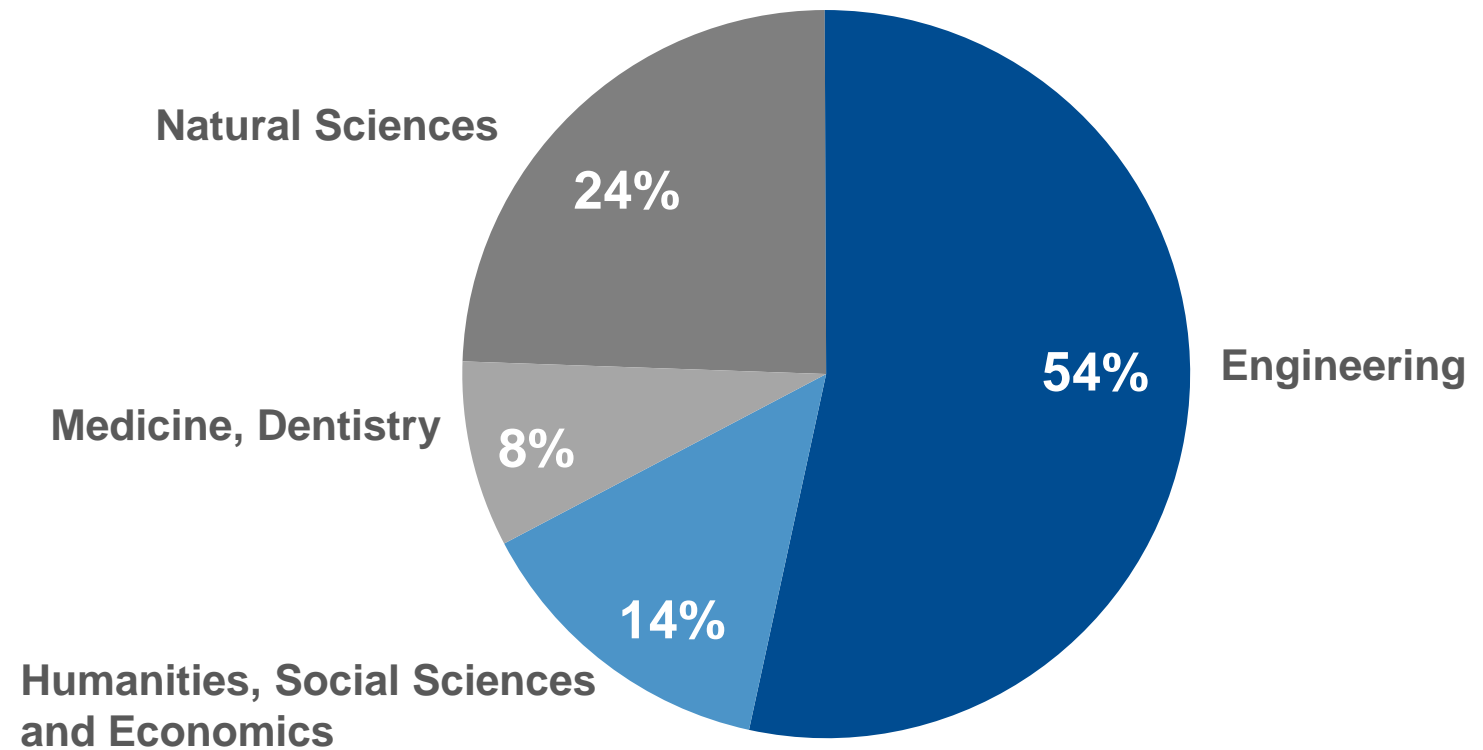

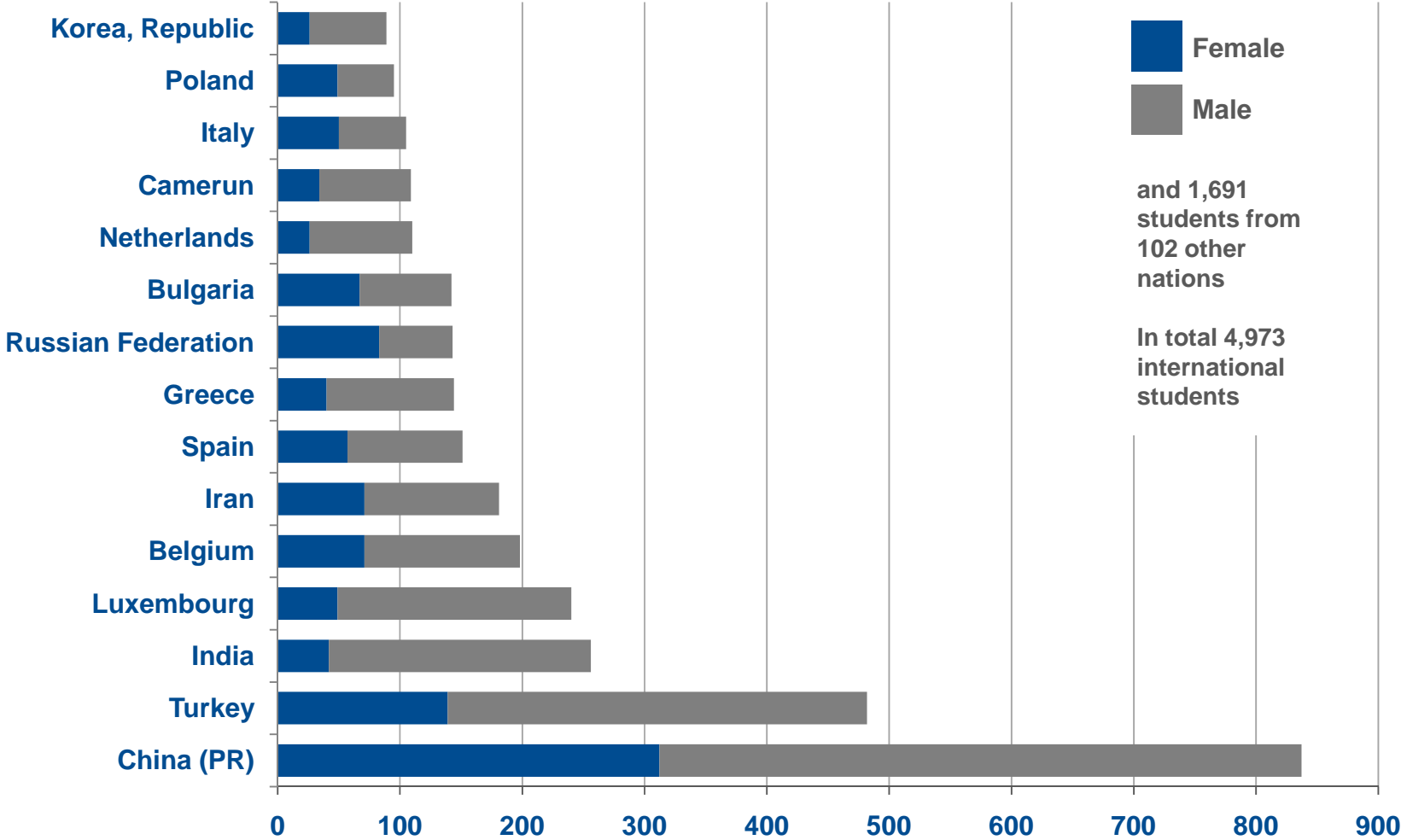

A total of 32,240 students

International Students per Country – Winter 2010/11



Excellent Universities in Germany

 Excellent in Research & Teaching

 Excellent in Research

 Excellent in Teaching

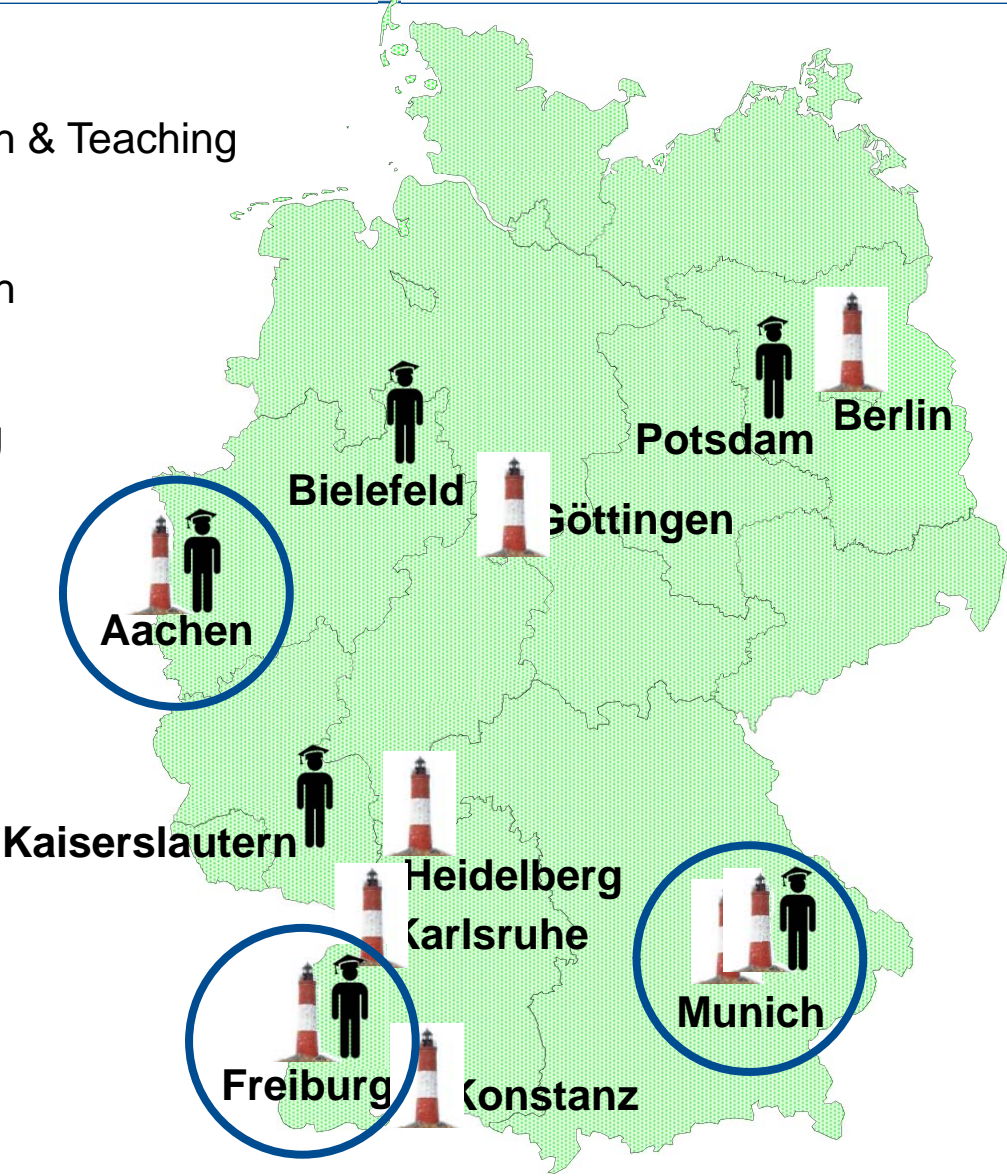

RWTH Aachen Campus - Aerial View



With its two new areas, RWTH Aachen University covers an area of approx. **2.5 km²**.

RWTH Aachen University is therefore one of the **largest technology-oriented campus areas in Europe**

The RWTH Aachen Campus:

Capital commitments:
1,500,000,000 €

New direct and indirect
jobs: approx.
10,000

Area: 546,000m²



Faculty of Civil Engineering

Which courses ...

... of study do we provide?

- **Civil Engineering** (B.Sc. RWTH / M.Sc. RWTH)
- **Waste Management** (B.Sc. RWTH / M.Sc. RWTH)
- **Business Administration and Engineering**
(as branch of Civil Engineering) (B.Sc. RWTH)
- **Environmental Engineering** (B.Sc. RWTH / M.Sc. RWTH)
- **Mobility and Traffic** (B.Sc. RWTH / M.Sc. RWTH)

How many ...

... people are involved?

- **students** (in total) \approx **1750**
 German Diplom degrees per year \approx **100**
- **Ph.D. degrees per year** \approx **20**
- **full professors** **19**
- **research associate / scientific assistants** **180**
- **third-party funds** (in Mio €) \approx **12**

What choices ...

... do we offer?

- **Structural Engineering**
- **Water Engineering**
- **Traffic Engineering & Urban planning**
- **Construction Management**

Which topics ...

... does the study cover?

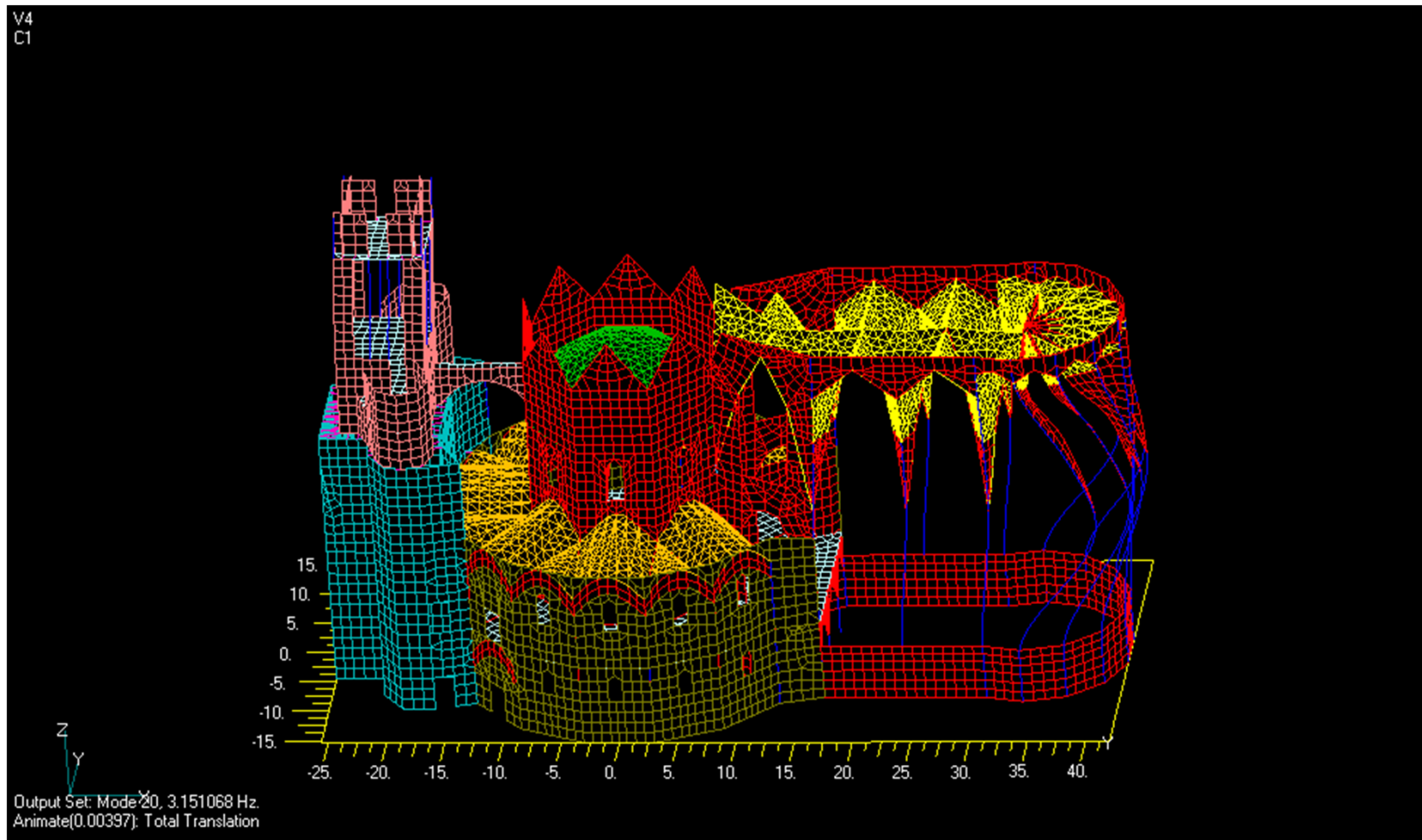

Institute of Structural Concrete



Test set up with forces up to 5 MN



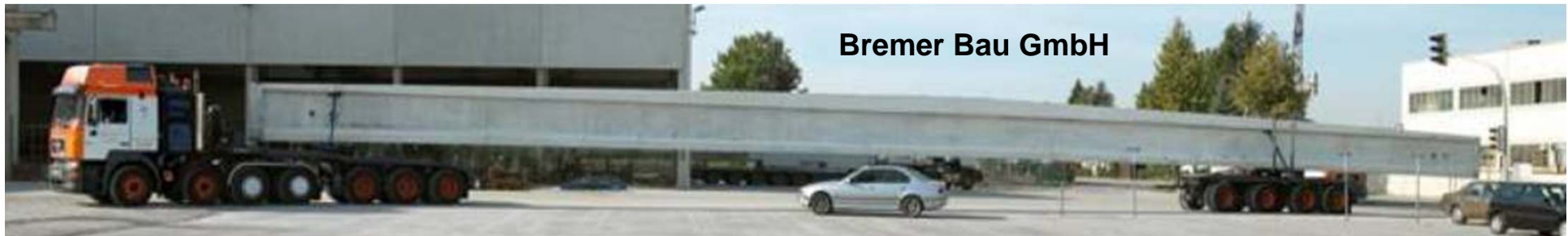
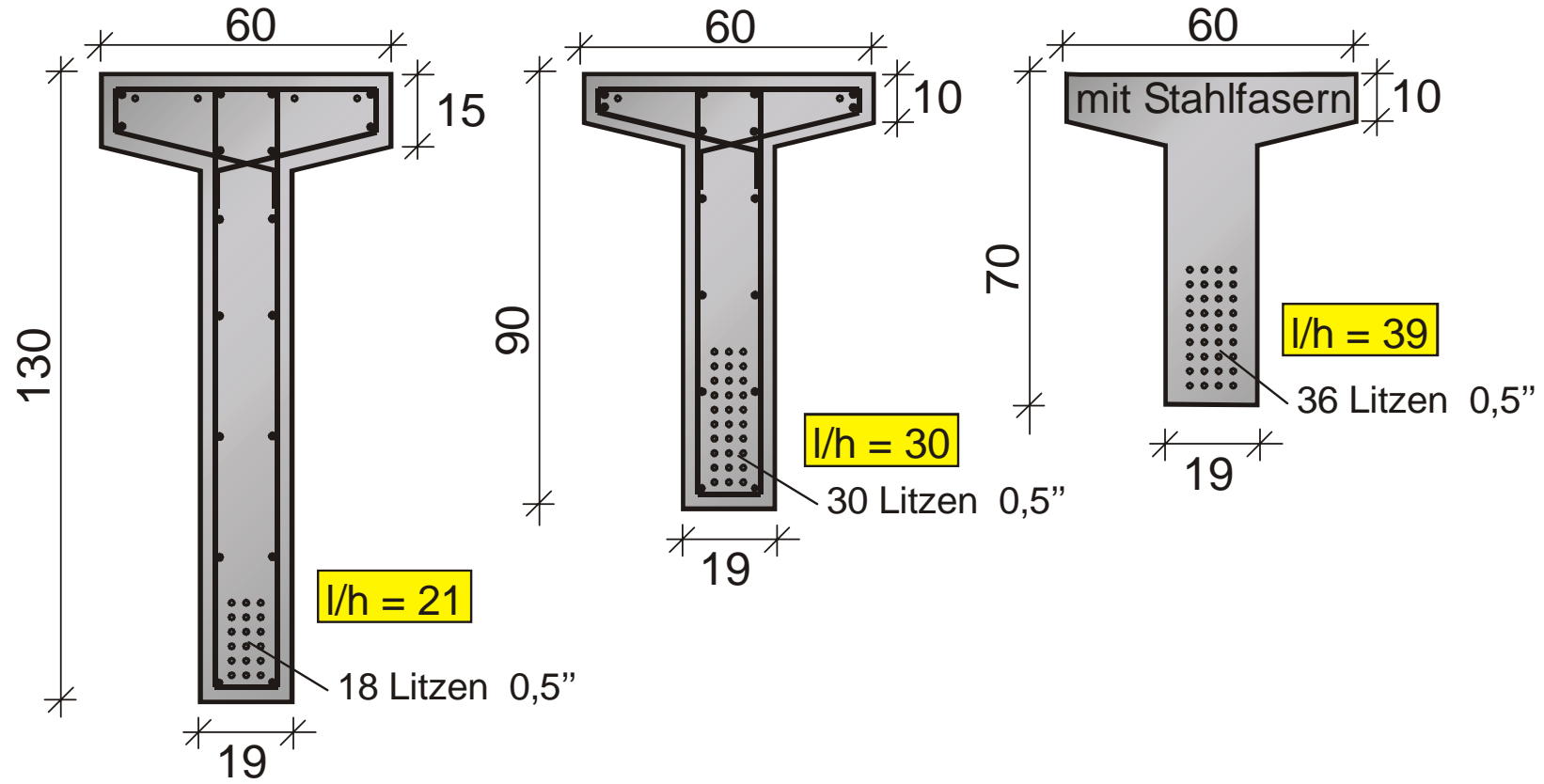

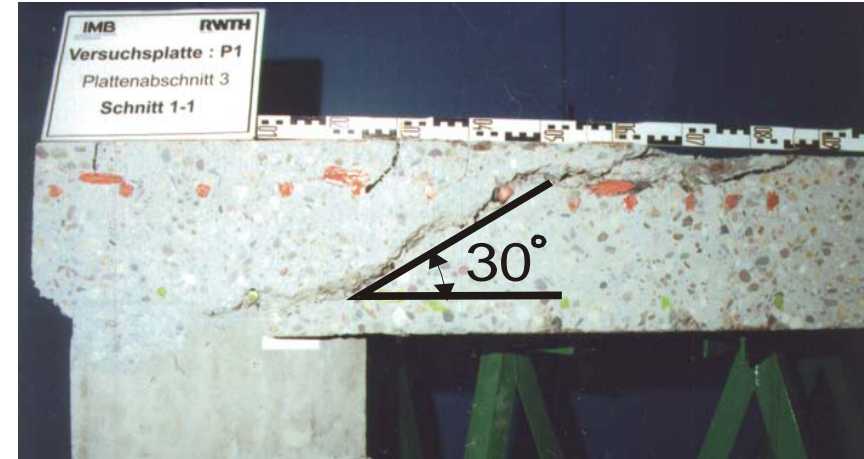
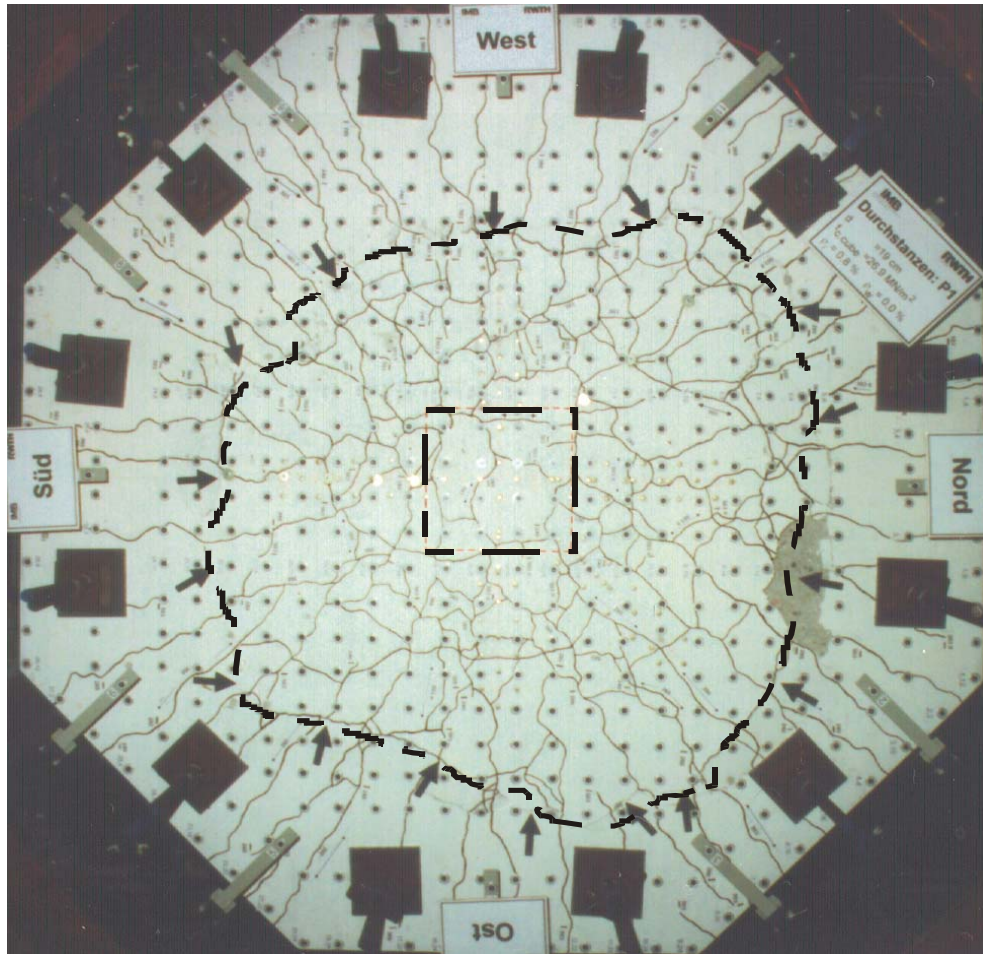

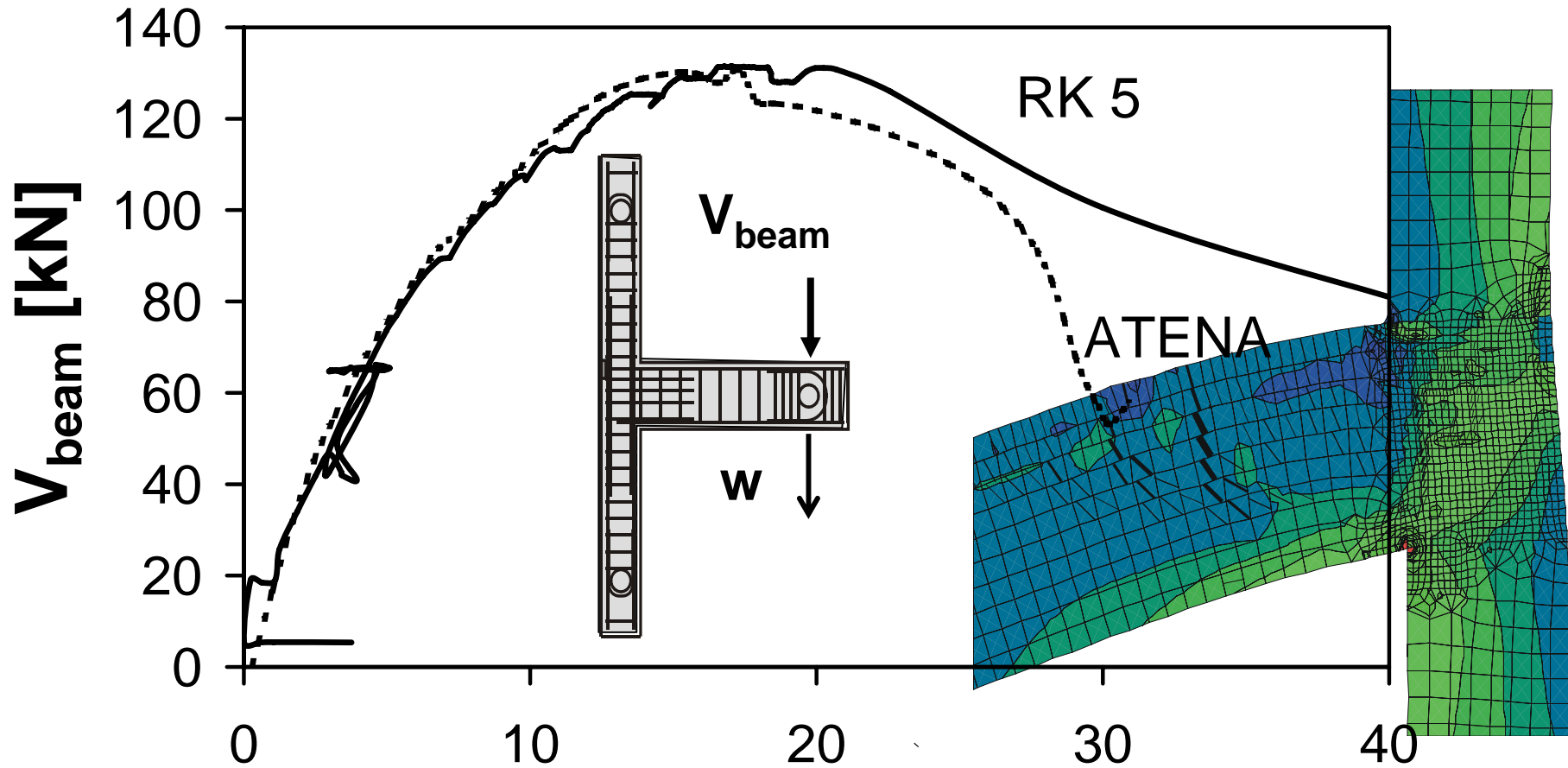



Textile Reinforced Concrete

